

Distributed and Operating Systems

Spring 2022

Prashant Shenoy

UMass CICS

<http://lass.cs.umass.edu/~shenoy/courses/677>

Course Syllabus

- COMPSCI 677: Distributed and Operating Systems
- *Course web page:* <http://lass.cs.umass.edu/~shenoy/courses/677>
 - Syllabus posted on the course web page.
- Class has two sections
 - Section 1 (classroom section)
 - Section 2 (online section)
 - Both sections do the same work (exams, lab, homework, etc)

Course Staff

- *Instructor*: Prashant Shenoy
 - Email: shenoy@cs.umass.edu, Phone: (413) 577 0850
 - Office hours: W: 3:45-4:45 LGRC A333 (*Initially held over zoom*)
- *Teaching Assistants*



Bin Wang

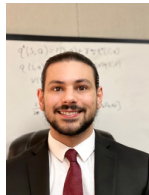

Chris Nota



Jorge Murillo



Hao Shi

TA Office Hours: TBD

- *Course/Grading Assistants*



Noel Varghese



Akshay Raju Lecture 1, page 3

UMassAmherst

Course Textbook

- *Textbook*: No textbook; will use notes and readings
- Suggested references (not mandatory)
- Distributed Systems, 3rd ed, by Tannenbaum and Van Steen, Prentice Hall 2017
 - PDF version of textbook is available for free from authors
 - Download your PDF copy from:
<https://www.distributed-systems.net/index.php/books/distributed-systems-3rd-edition-2017/>
 - Print copy: Hardcopy available from Amazon Textbook store
- Older 2nd Edition is also available as a PDF:
 - <https://www.distributed-systems.net/index.php/books/distributed-systems/>

Course Outline

- Introduction (*today*)
 - What, why, why not?
 - Basics
- Distributed Architectures
- Interprocess Communication
 - RPCs, RMI, message- and stream-oriented communication
- Processes and their scheduling
 - Thread/process scheduling, code/process migration, virtualization
- Naming and location management
 - Entities, addresses, access points

Course Outline

- Canonical problems and solutions
 - Mutual exclusion, leader election, clock synchronization, ...
- Resource sharing, replication and consistency
 - DFS, consistency issues, caching and replication
- Fault-tolerance
- Security in distributed Systems
- Distributed middleware
- Advanced topics: web, cloud computing, green computing, big data, multimedia, and mobile systems

Course Grading

- *Grading*
 - Homeworks (**8%**), 3-4 programming assignments (**50%**),
 - 1 mid-term and 1 final exam (**40%**) [Midterm: March 25]
 - class participation+quizzes+online discussions: **2%**
- *Pre-requisites*
 - Undergrad course in operating systems
 - *Good* programming skills in a high-level prog. language

Course Tools

- *Piazza* : online discussion forum. Register at:
 - <https://piazza.com/umass/spring2022/compsci677>
- *Gradescope*: Used for written assignments (homework and quizzes)
- *Github Classroom* : Used for programming assignments

- *Web page*: <https://lass.cs.umass.edu/~shenoy/courses/677>
- *Youtube Channel*: <https://youtube.com/umassos>
- *Moodle*: Mostly used as an online grade book

Course Policies

- Class Participation: Need a scribe for each class

- Mask Policy:

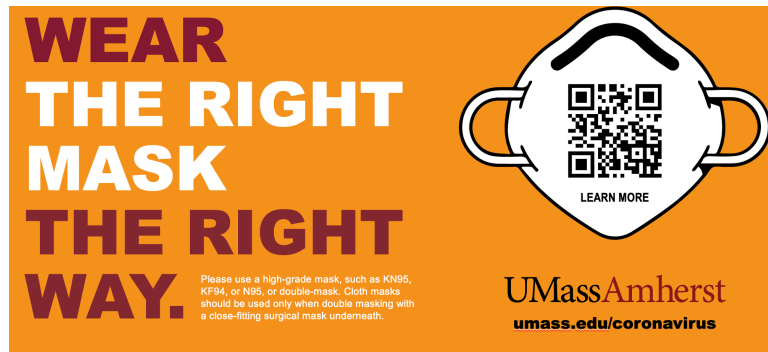

- Device Policy:



UMassAmherst

Lecture 1, page 9

Module 2: Why Distributed Systems?

- Many systems that we use on a daily basis are distributed
 - World wide web, Google
 - Cloud computing
 - Amazon.com
 - Peer-to-peer file sharing systems
 - SETI@Home
 - Grid and cluster computing
 - Modern networked computers
- Useful to understand how such real-world systems work
- Course covers basic principles for designing distributed systems

Definition of a Distributed System

- A distributed system:
 - Multiple connected CPUs working together
 - A collection of independent computers that appears to its users as a single coherent system
- Examples: parallel machines, networked machines

Advantages and Disadvantages

- Advantages
 - Communication and resource sharing possible
 - Economics – price-performance ratio
 - Reliability, scalability
 - Potential for incremental growth
- Disadvantages
 - Distribution-aware PLs, OSs and applications
 - Network connectivity essential
 - Security and privacy

Transparency in a Distributed System

Transparency	Description
Access	Hide differences in data representation and how a resource is accessed
Location	Hide where a resource is located
Migration	Hide that a resource may move to another location
Relocation	Hide that a resource may be moved to another location while in use
Replication	Hide that a resource may be replicated
Concurrency	Hide that a resource may be shared by several competitive users
Failure	Hide the failure and recovery of a resource
Persistence	Hide whether a (software) resource is in memory or on disk

Different forms of transparency in a distributed system.

Open Distributed Systems

- Offer services that are described a priori
 - Syntax and semantics are known via protocols
- Services specified via interfaces
- Benefits
 - Interoperability
 - Portability
- Extensibility
 - Open system evolve over time and should be extensible to accommodate new functionality.
 - Separate policy from mechanism

Scalability Problems

Concept	Example
Centralized services	A single server for all users
Centralized data	A single on-line telephone book
Centralized algorithms	Doing routing based on complete information

Examples of scalability limitations.

Scaling Techniques

- *Principles* for good decentralized algorithms
 - No machine has complete state
 - Make decision based on local information
 - A single failure does not bring down the system
 - No global clock
- *Techniques*
 - Asynchronous communication
 - Distribution
 - Caching and replication

Module 3: Distributed Systems History and OS Models

- Minicomputer model (e.g., early networks)
 - Each user has local machine
 - Local processing but can fetch remote data (files, databases)
- Workstation model (e.g., Sprite)
 - Processing can also migrate
- Client-server Model (e.g., V system, world wide web)
 - User has local workstation
 - Powerful workstations serve as servers (file, print, DB servers)
- Processor pool model (e.g., Amoeba, Plan 9)
 - Terminals are Xterms or diskless terminals
 - Pool of backend processors handle processing

Distributed System Models (contd)

- Cluster computing systems / Data centers
 - LAN with a cluster of servers + storage
 - Linux, Mosix, ..
 - Used by distributed web servers, scientific applications, enterprise applications
- Grid computing systems
 - Cluster of machines connected over a WAN
 - SETI @ home
- WAN-based clusters / distributed data centers
 - Google, Amazon, ...
- Virtualization and data center
- Cloud Computing

Emerging Models

- Distributed Pervasive Systems
 - “smaller” nodes with networking capabilities
 - Computing is “everywhere”
 - Home networks: TiVO, Windows Media Center, ...
 - Mobile computing: smart phones, iPODs, Car-based PCs
 - Sensor networks
 - Health-care: personal area networks
 - Sustainability as a design goal

Uniprocessor Operating Systems

- An OS acts as a resource manager or an arbitrator
 - Manages CPU, I/O devices, memory
- OS provides a virtual interface that is easier to use than hardware
- Structure of uniprocessor operating systems
 - Monolithic (e.g., MS-DOS, early UNIX)
 - One large kernel that handles everything
 - Layered design
 - Functionality is decomposed into N layers
 - Each layer uses services of layer N-1 and implements new service(s) for layer N+1

Microkernel Operating Systems

Microkernel architecture

- Small kernel
- user-level servers implement additional functionality

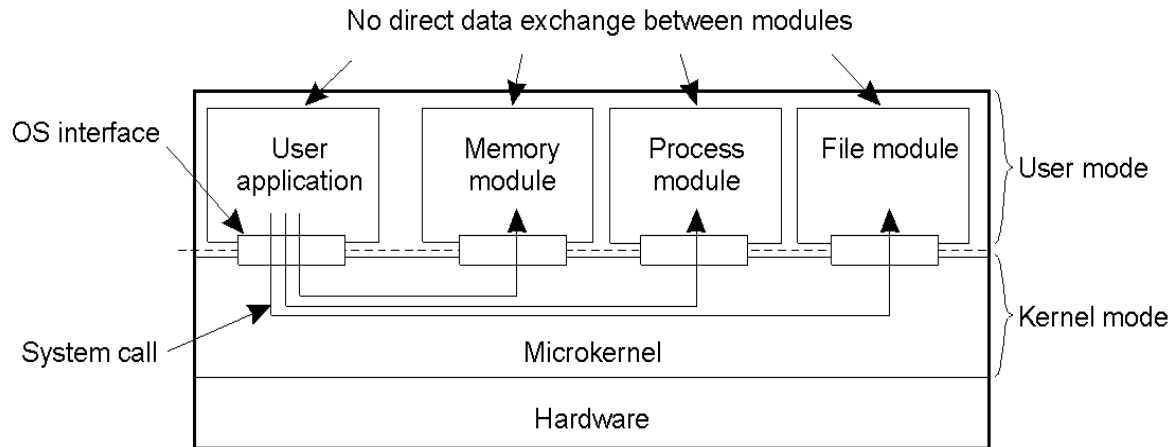

Distributed Operating System

- Manages resources in a distributed system
 - Seamlessly and transparently to the user
- Looks to the user like a centralized OS
 - But operates on multiple independent CPUs
- Provides transparency
 - Location, migration, concurrency, replication,...
- Presents users with a virtual uniprocessor

Types of Distributed OSs

System	Description	Main Goal
DOS	Tightly-coupled operating system for multi-processors and homogeneous multicomputers	Hide and manage hardware resources
NOS	Loosely-coupled operating system for heterogeneous multicomputers (LAN and WAN)	Offer local services to remote clients
Middleware	Additional layer atop of NOS implementing general-purpose services	Provide distribution transparency

Multiprocessor Operating Systems

- Like a uniprocessor operating system
- Manages multiple CPUs transparently to the user
- Each processor has its own hardware cache
 - Maintain consistency of cached data

Multicomputer Operating Systems

Example: MOSIX cluster - single system image

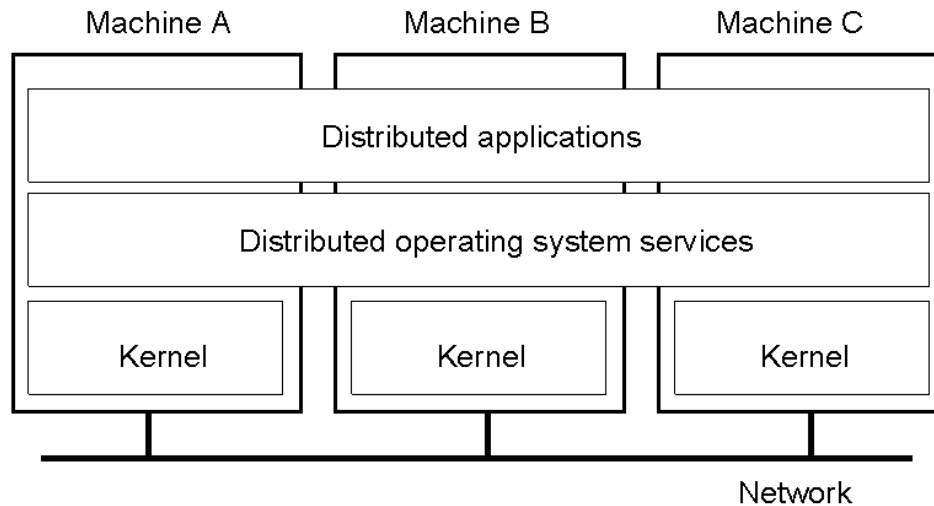

Network Operating System

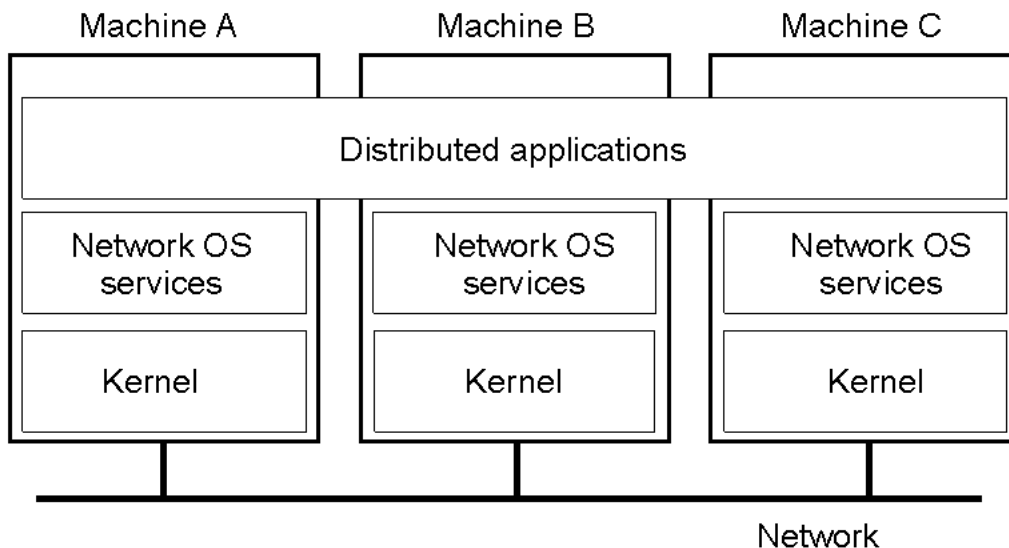

Network Operating System

- Employs a client-server model
 - Minimal OS kernel
 - Additional functionality as user processes

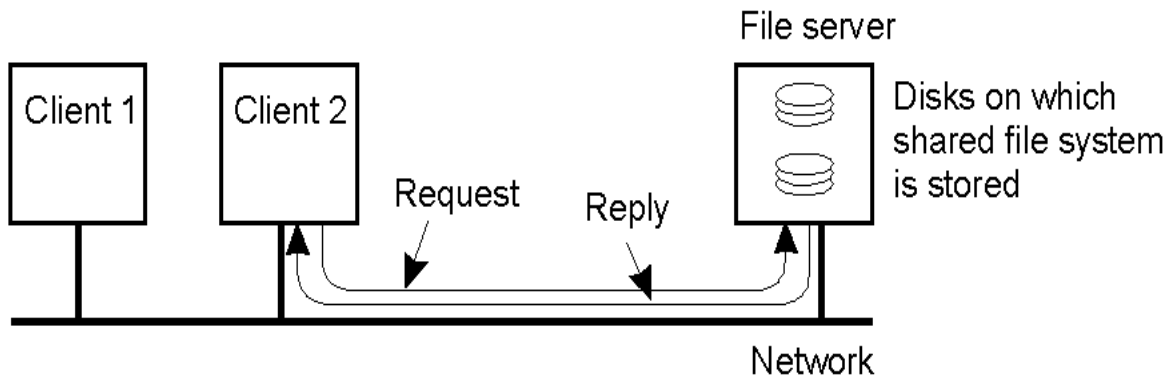

Middleware-based Systems

- General structure of a distributed system as middleware.

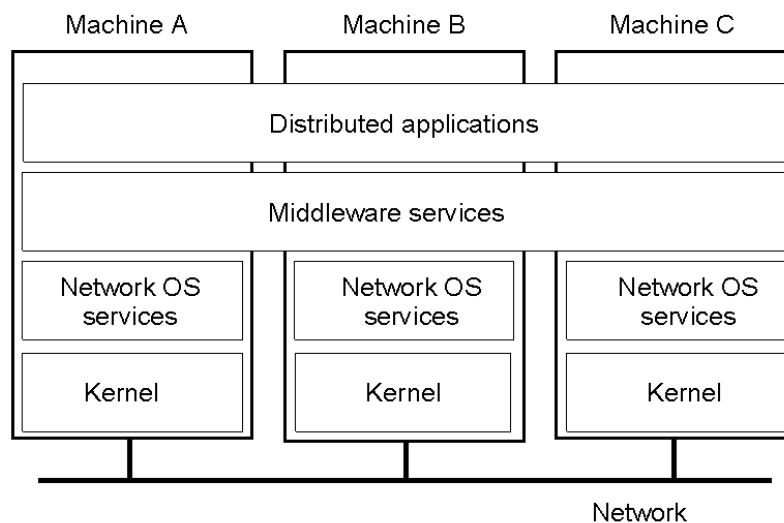

Comparison between Systems

Item	Distributed OS		Network OS	Middleware-based OS
	Multiproc.	Multicomp.		
Degree of transparency	Very High	High	Low	High
Same OS on all nodes	Yes	Yes	No	No
Number of copies of OS	1	N	N	N
Basis for communication	Shared memory	Messages	Files	Model specific
Resource management	Global, central	Global, distributed	Per node	Per node
Scalability	No	Moderately	Yes	Varies
Openness	Depends on OS	Depends on OS	Open	Open